



# [BYNATURE]

*Enjoy. Breathe. Feel good.*

CATALOGUE

## SPECIALISTS IN BIOPHILIC DESIGN

We create strong connections between nature and the indoor environment

### BYNATURE VISION

Nature plays an essential role in our lives by improving our wellness, happiness, health, and even our productivity. Yet, while we spend 85% of our time indoors, there is still an increasing lack of nature in our living and work spaces.

ByNature believes that any indoor space can be transformed into a healthy living environment. We aspire to bring nature into everyone's lives by creating an experience for people to *enjoy, breathe, and feel good.*



### BYNATURE MISSIONS

ByNature's team of passionate people are dedicated to using their knowledge of biophilic design principles to enliven your home or office space with nature.

ByNature's vision, however, could not happen without its growing network of visionary partners (architects, designers, landscapers, engineers, and creative visionaries alike). Together, we bring our *unique expertise* to the table to promote, educate and innovate by creating and sourcing new leading-edge technologies that make your space a better place.

### CANADA & UNITED STATES

ByNature is present across North America and has a network of *brand ambassadors* throughout the **United States** and **Canada**. Our network of experienced brand representatives, offers exceptional guidance throughout the entire process.

No matter your project size or location, connect with a ByNature brand representative today and discover how biophilic design can create a healthier, happier, and more productive work environment for you.

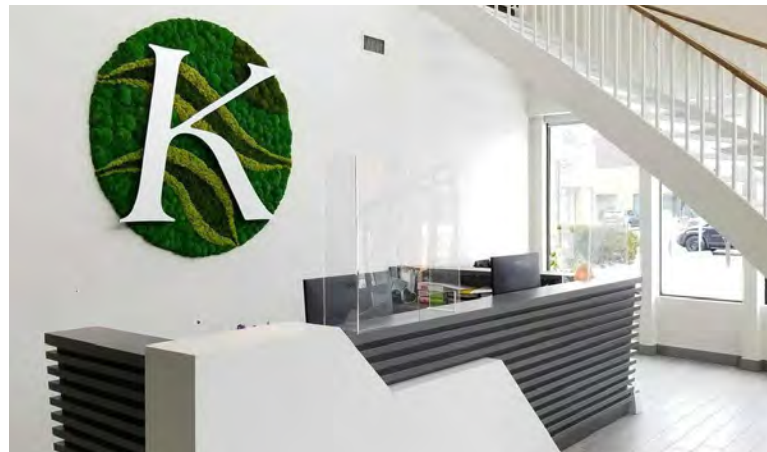

### OUR SERVICES



Consultation



Design



Manufacture



Maintenance



Installation

## CONTENTS



### PRESERVED

4

- Mossart 6
- Reindeer Moss 8
- Spheres & Rings 12
- Mossart Logo Options 14
- Mixed Moss Walls 16
- Pole Moss 18
- Textured Moss 19
- Sheet Moss & Rock Moss 20
- Folia Preserved Plants 22
- Preserved Trees 26



### FAUX

28

- Faux Plants 29
- Faux Panels 32
- Faux Ceilings 36



### LIVING

39

- Live Pictures & Live Dividers 40
- Nextgen Living Walls 43
- Mobile Walls 45



### PLANTERS

46

- Self Watering Planters 47
- Custom Planters 48



### SUSPENDED GREENERY

53

- Well Planter 54
- Well Planter Light 55
- Hemisphere Planter 56
- Hemisphere Pendant Planter 57
- Babylon Light 58



### NATURAL WALL COVERING

59

- Naturacork 60
- Gencork 61
- PapierFlora 62

## WHAT IS PRESERVED?

Mossart and Folia creations are made with 100% natural mosses, flowers and plants that require no watering, natural light, nor trimming.

Cultivated or harvested according to ecological practices, the mosses, plants and flowers are no longer living and require little to low maintenance. They are preserved without the use of chemicals by using both a natural oil and natural food dyes. As the oil mimics the water in the plant, they still appear live and can maintain a natural appearance for months or years to come (6 months to 5-10 years for plants/flowers and 8+ years for the preserved mosses; please refer to life expectancy of individual plants).

## HOW TO MAINTAIN PRESERVED MOSSART OR FOLIA PIECES?

Preserved products are for indoor-use applications only and their softness may vary according to the relative humidity of the room. In the case of a very dry environment (below 30% humidity), the reindeer moss or plants may become dry or harden. Once returned to normal room temperature and humidity levels, however, it may become soft again. This variation is usually related to the season. A relative humidity considered as "normal" is between 45 and 65%.

Be aware that the "softness state" of the plant does not change its look. Once returned to normal room temperature and humidity levels, however, the reindeer moss will become soft again. When near end of life expectancy, preserved plants and flowers may begin to dry and as a result change form. Replanting or touch-ups may be requested at this stage. Never water or spray preserved products and avoid keeping them in direct sunlight for prolonged periods. This will help ensure the preserved products reach their longest life expectancy and maintain their colour, shape and texture.

## IMPORTANT NOTES

You may experience a natural scent for a few months, which will progressively fade. If required, the moss may be carefully dusted using a blow dryer on a low temperature setting.

Preserved products are natural and will usually have some varieties in colour.



# PRESERVED

Our plants and mosses are preserved in an innovative and eco-friendly way using 100% natural oils and food dye. This allows the plants to maintain their authenticity without the need for maintenance.

# MOSSART

Our Mossart creations are 100% natural and made with preserved moss. They are custom and do not require any natural light, traimming, or watering.

## MOSS PANELS

For wall applications

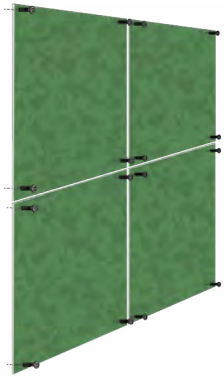

### PANEL INSTALLATION

- Pre-made panels
- Simply screw panels in place
- Custom sizes and shapes
- Seamless look

### BACKING OPTIONS

- Ecofelt (made of recycled plastic bottles)
- Flexifelt (curved surfaces)
- Cork
- Wood
- Coroplast\*

\*Standard backing is Coroplast. Other options are available for additional fees.

## MOSSART EDGES

Available finishes for edges



Bare Edge



Mossart Edge



Aluminium Trim



Wooden Trim



Wooden Frame

## MOSSART IN A FRAME

Wood frame options



Custom options available!



Ash Whitewashed



Ash Clear



Walnut Stained



White Painted



Grey Stained



Ink Black

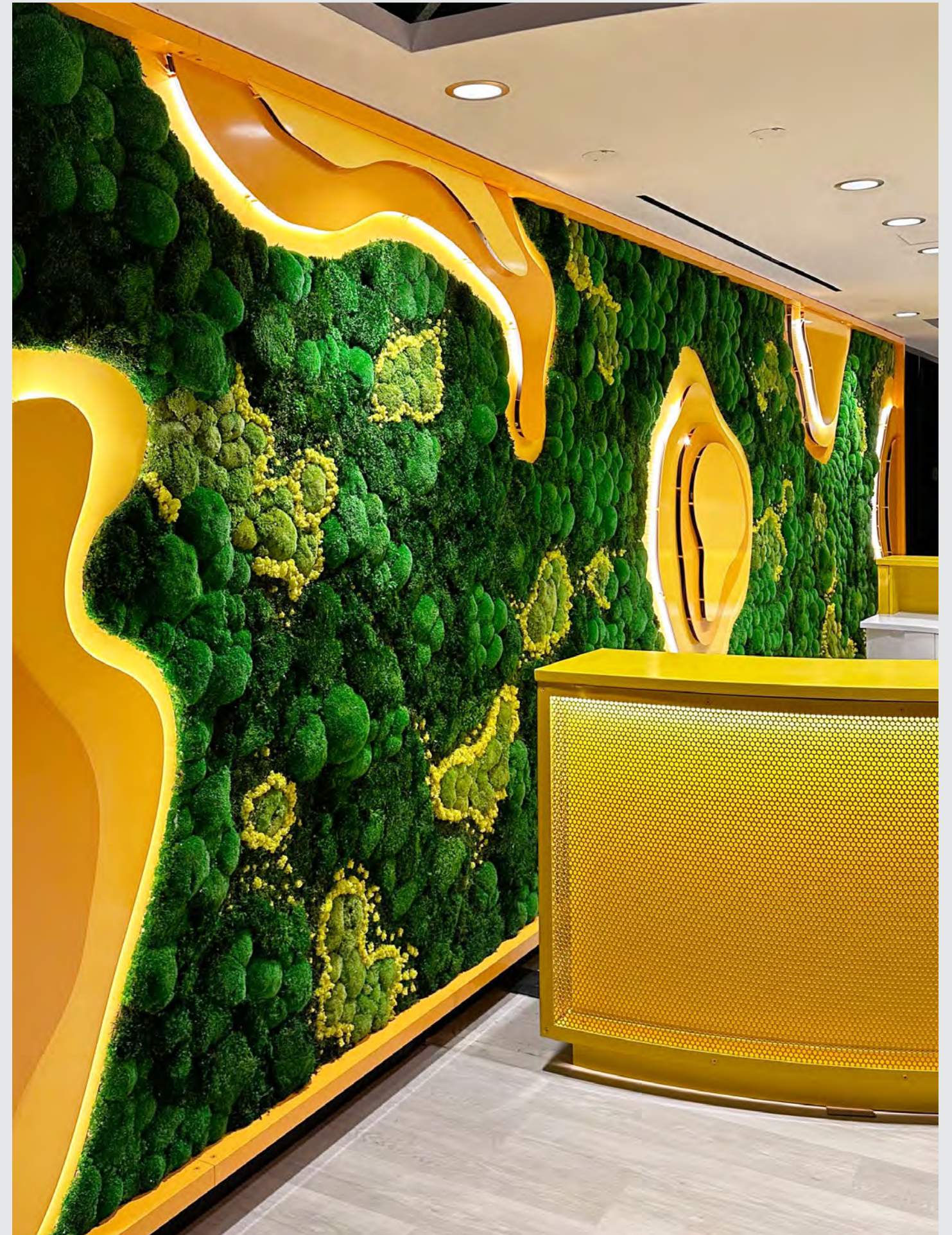

# REINDEER MOSS

ByNature Reindeer Moss, actually a lichen, is our most popular moss for both large and small applications. From natural to bold shades, Reindeer Moss comes in more than 25 different colours to create unique and lush designs.



2" thick and dyed using food grade dye. Custom colours available for large volumes. Non-dyed natural coloured moss also available.

Dark Green CA

## TEXTURE OPTIONS

### Grade A

Higher quality using only the top part of the moss.



### Grade B

Made with top and bottom parts of the moss.



Dark Green NO

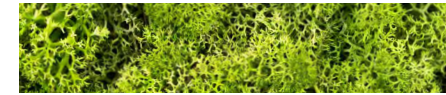

Medium Green NO



Olive NO



Spring Green NO

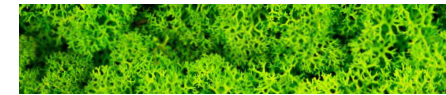

Grass Green Light NO



Grass Green NO



Pine NO



Mint NO

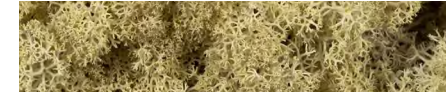

Natural NO



Silver Grey NO

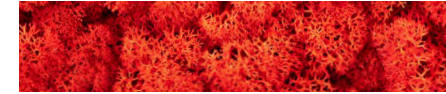

Red NO

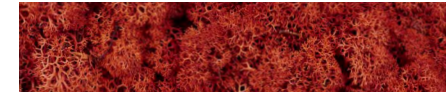

Sienna NO



Yellow NO

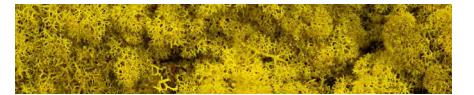

Lemon NO

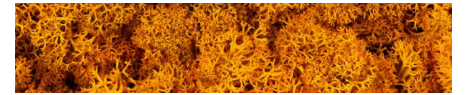

Orange NO



Purple NO

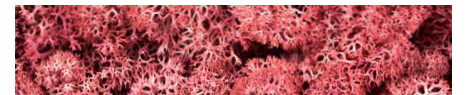

Burgundy NO



Pink NO

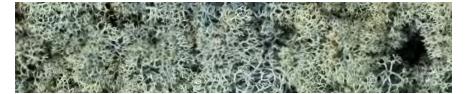

Ice Blue NO

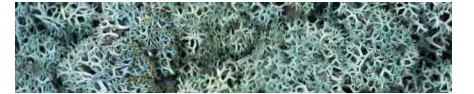

Blue Lavender NO

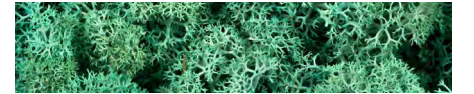

Pacific Blue NO



Azure NO

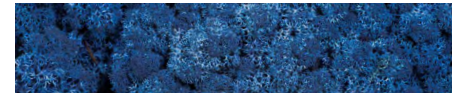

Classic Blue NO

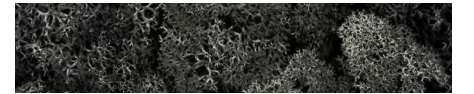

Charcoal NO

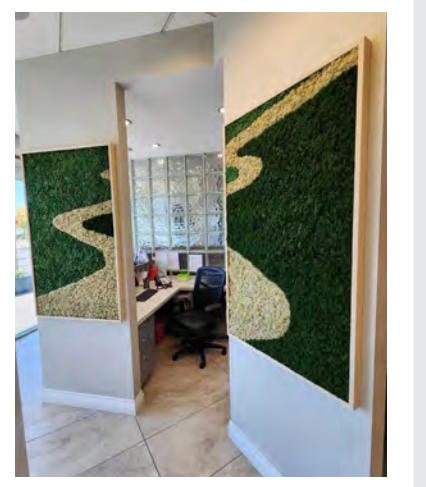
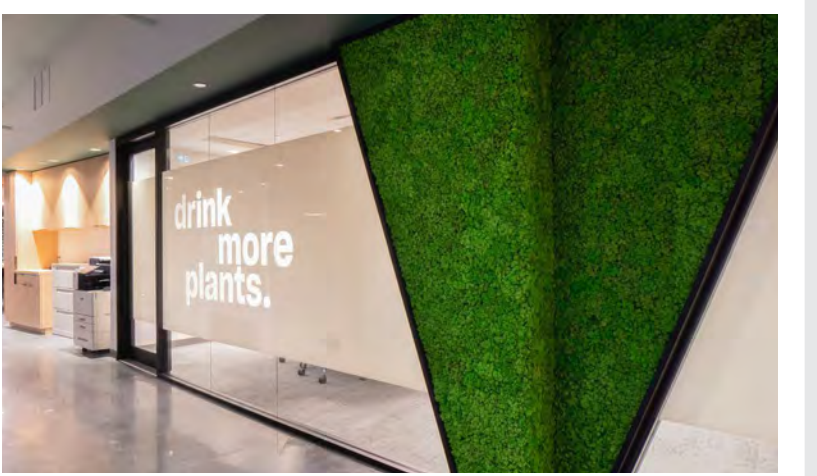
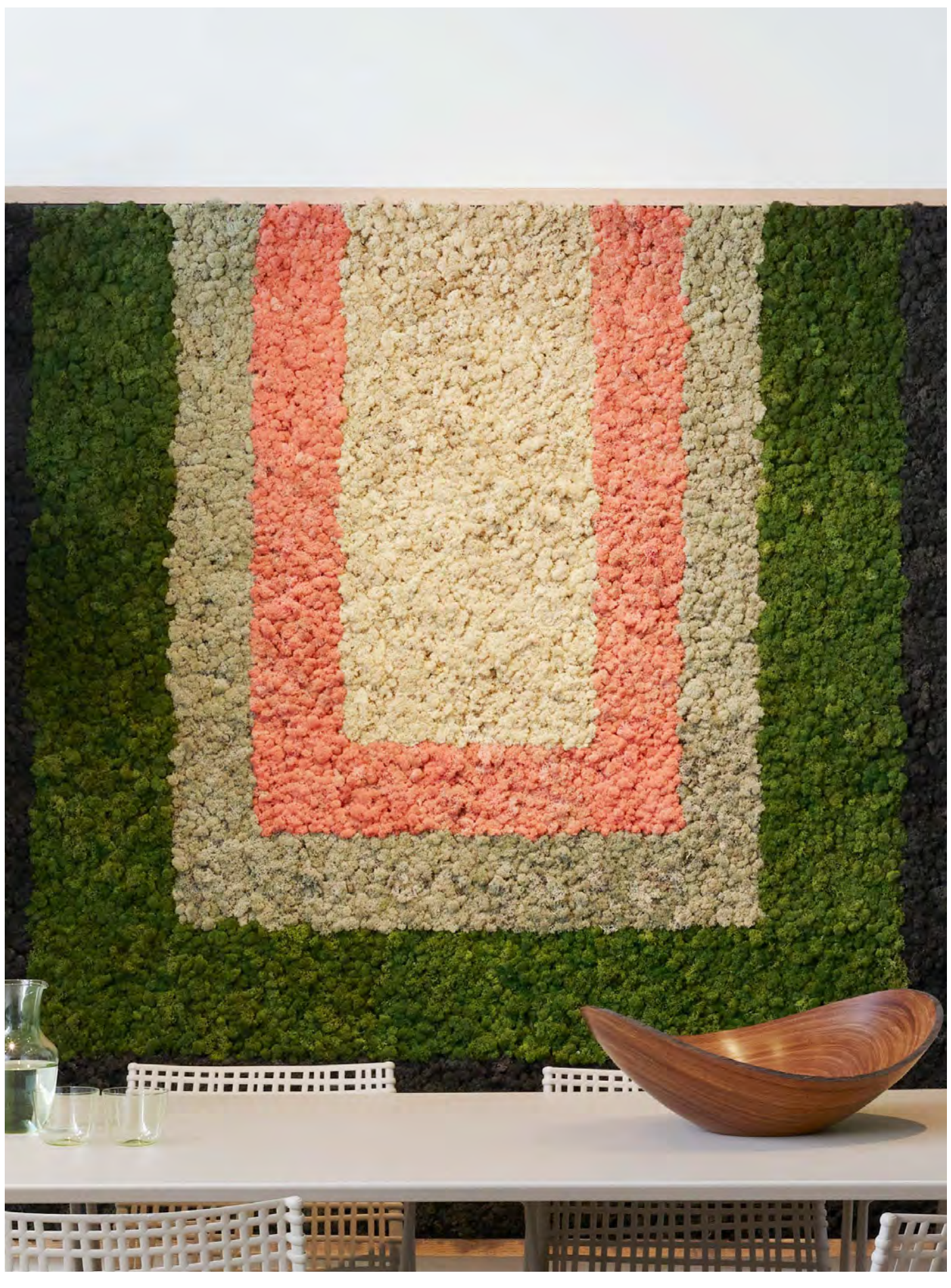



## SPHERES

Spheres are lightweight moss balls with sound dampening properties that are designed to be suspended from the ceiling. They are made from Reindeer Moss and can be ordered in any of the colours we stock.

Sphere Sizing Options (Diameter)  
(3") (6") (8") (12") (16") (24") (30")

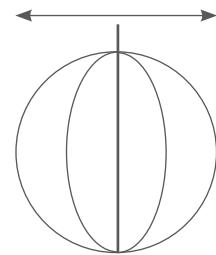

Custom sizes available upon request



## RINGS

Rings are moss circles in beautiful, round, natural wood frames that can easily be hung onto your wall or set on a table as a decor piece. You can choose any moss type and colour that we stock to fill your frame, giving you a larger variety of textures and colours to design with.

Ring Sizing Options (Diameter)

(15") (17") (20")

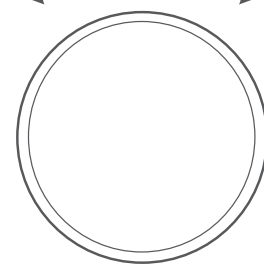

Custom sizes available upon request

3" - 4"



### ACCOUSTIC FUNCTION

Mossart Panels have significant sound-absorption.

According to a study conducted by the Centre for Architectural Ecology at the British Columbia Institute of Technology (BCIT), sound absorption is relatively high with signal number ratings (NRC and SAA) in the range of a 3/4"-1" fibre board, or a carpet on underlay pad.

Absorption in this range can be useful in classrooms and conference rooms to improve speech intelligibility and the quality of verbal communication.

### FLAMMABILITY

ByNature unicolour reindeer Mossart Panels have been tested for flammability.

The method, designated as CAN/ULC-S102-10, Standard Method of Test for Surface Burning Characteristics of Building Materials and Assemblies", is designed to determine the relative surface burning characteristics of materials under specific test conditions.

After testing three identical specimens, results confirmed that ByNature Mossart panels have an average Flame Spread Rating (FSR) of 95 and an average Smoke Developed Classification (SDC) of 445.

# MOSSART LOGO OPTIONS

A logo is a key element of an organization's visual identity. Adding your custom-built logo to your office lobby, reception area, waiting room, meeting room or restaurant creates a memorable branding of your organization's professional space.

ACRYLIC



ACRYLIC CHANNEL LETTERS



BACKLIT



CUT LETTERS COVERED



EMBEDDED WOOD LETTERS



METAL CHANNEL LETTERS



METAL LETTERS



MOSS LOGO



NEON LED SIGN

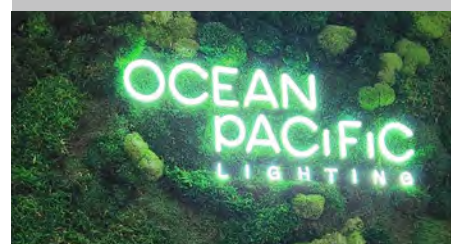

WOOD CHANNEL LETTERS



WOOD LOGOS



# MIXED MOSS WALLS

With its organic mix of mosses, this is one of the most natural looking Mossart wall application we have.

(c) photo: teatrx inc.

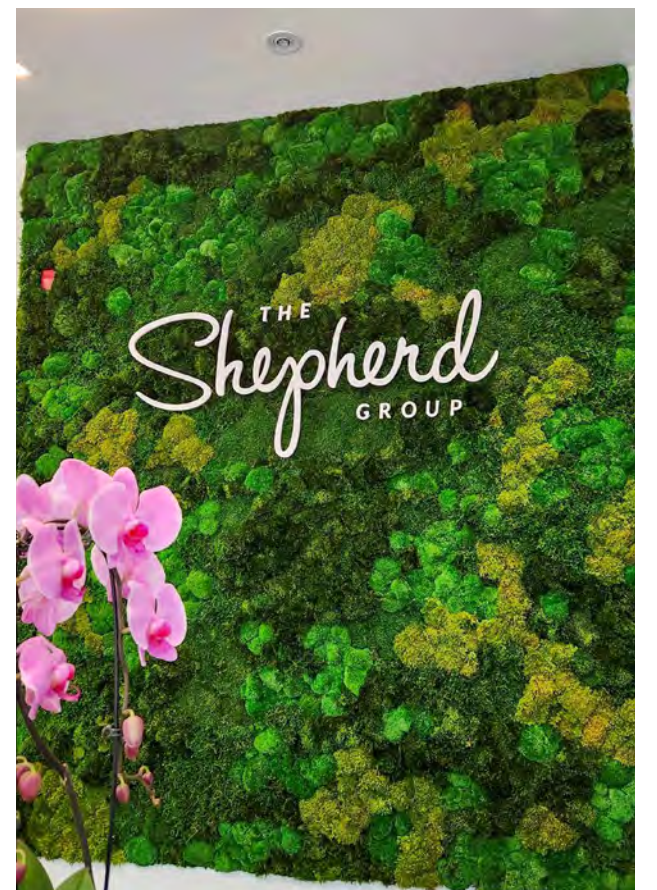
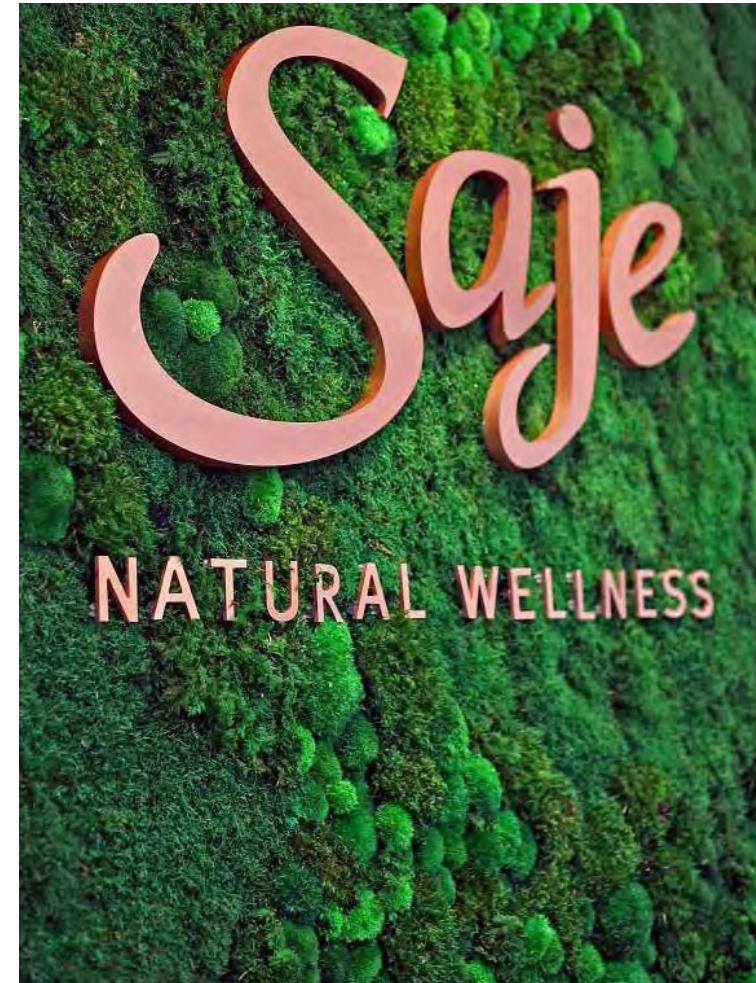
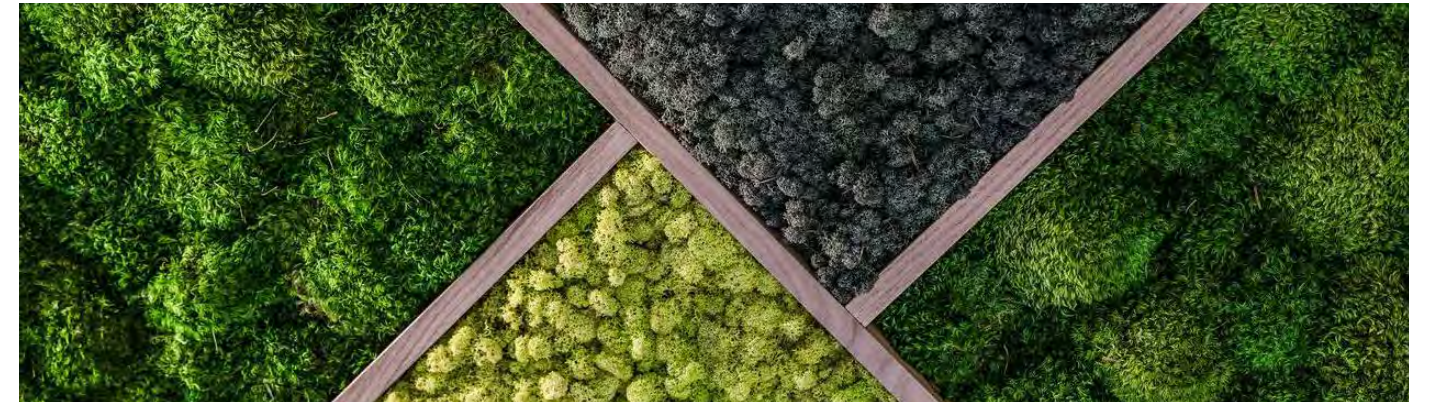

## POLE MOSS

ByNature Pole Moss add a fun and naturally rounded texture to any space. Pole moss can be used to create original décor and is usually used in wall or ceiling applications. It is available in many different shades and sizes. Standard panels are approximately 2" to 3" thick.

More options available!



## TEXTURED MOSS

Our textured moss species are our range of lesser known but equally distinguishable mosses. Their unique textures can provide more depth and naturally soft forms to your space.

More options available!

Colombian moss



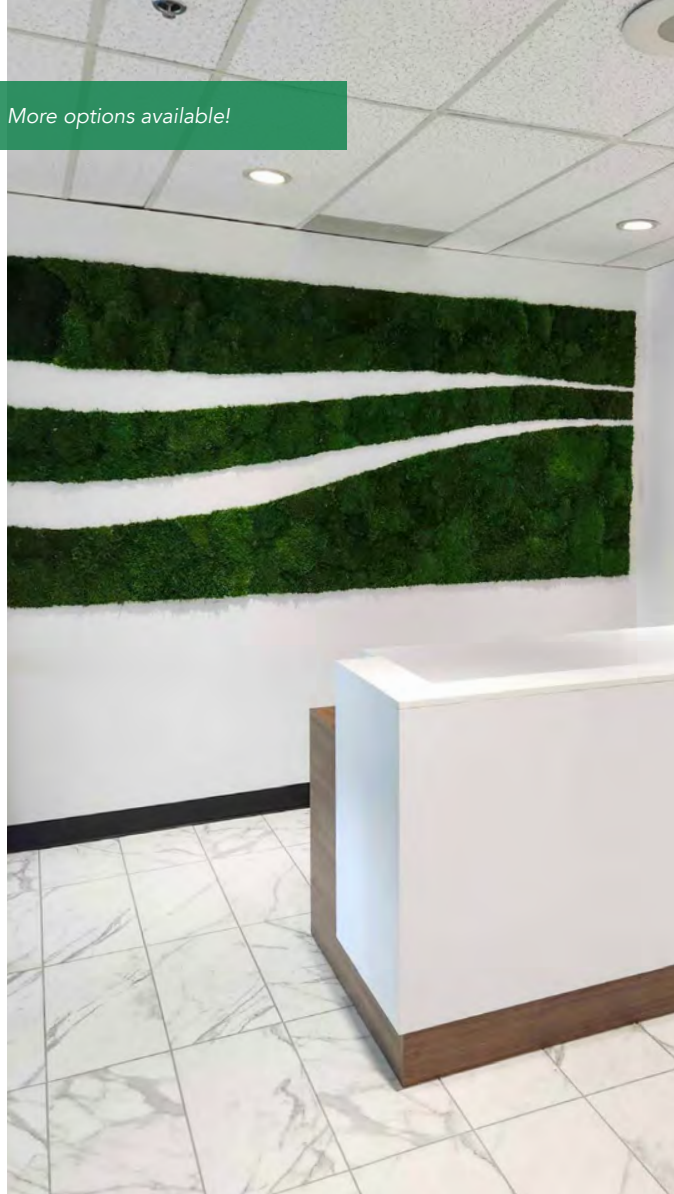

More options available!

## SHEET AND ROCK MOSS

ByNature Sheet and Rock Moss bring a very natural and organic feel to a space. Sheet and Rock moss can be used to create original decor and is often applied as a wall or ceiling covering. It exists in different shades of green, preserved and dried. Standard panels are approximately 3/4" thick.



Preserved Sheet Moss  
Dark Green



Preserved Sheet Moss  
Light Green



Dried Sheet Moss



Preserved Rock Moss  
Light Green



## FOLIA PRESERVED PLANTS

ByNature's exclusive line of 100% natural and preserved foliage can be used to create an array of distinctive pieces including table centre pieces, unique frames, ceilings and wall coverings. This natural décor will last for years with limited maintenance (no natural light, trimming or water required).



- No size or design limitations
- 70+ plant varieties available
- 20+ flower varieties available
- 100% natural
- Low maintenance
- No water or light required
- Long lasting preserved natural décor

Contact us for full of preserved foliage and flowers!

ABOUT 25% COVERAGE



ABOUT 50% COVERAGE



ABOUT 75% COVERAGE



MORE THAN 75% COVERAGE

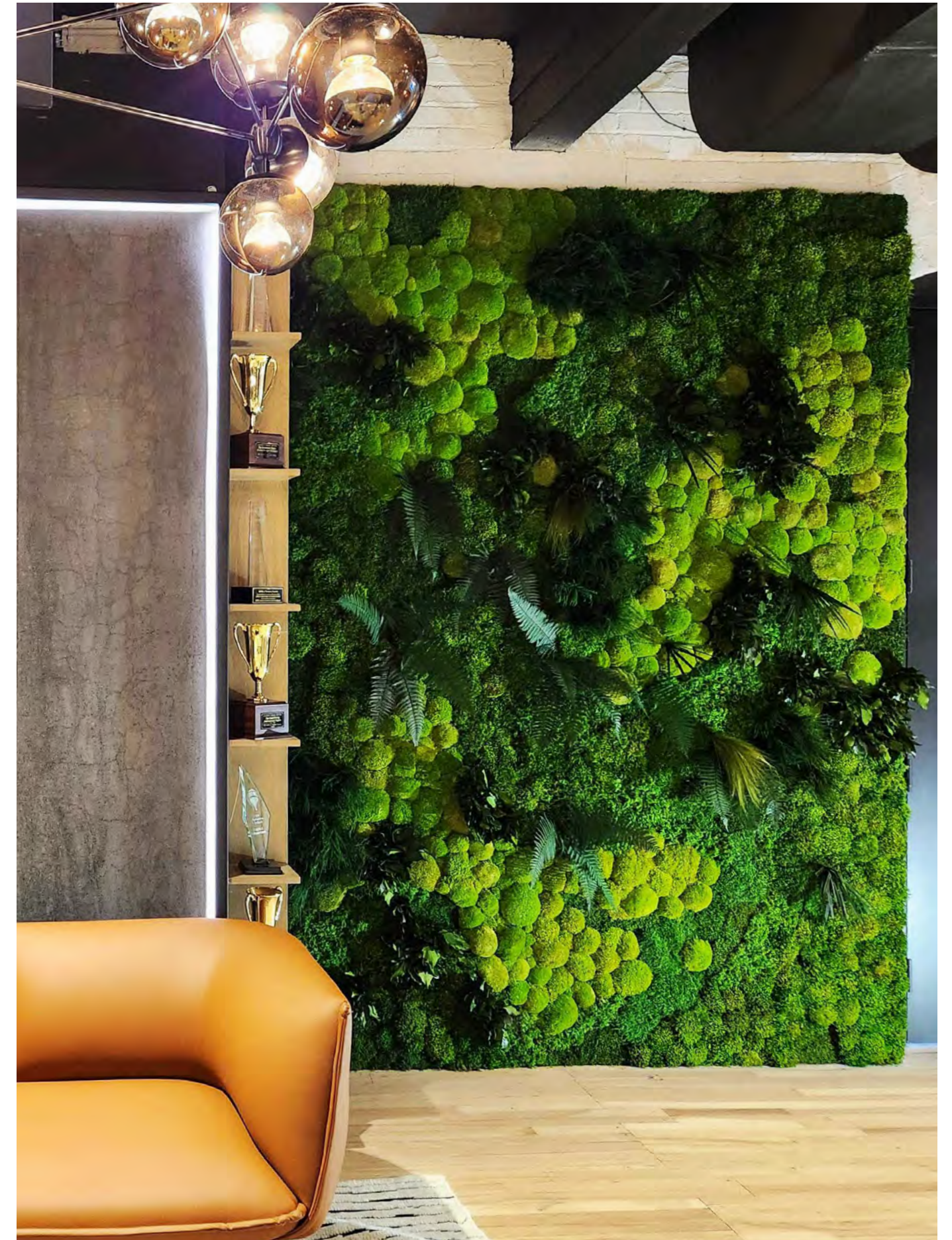

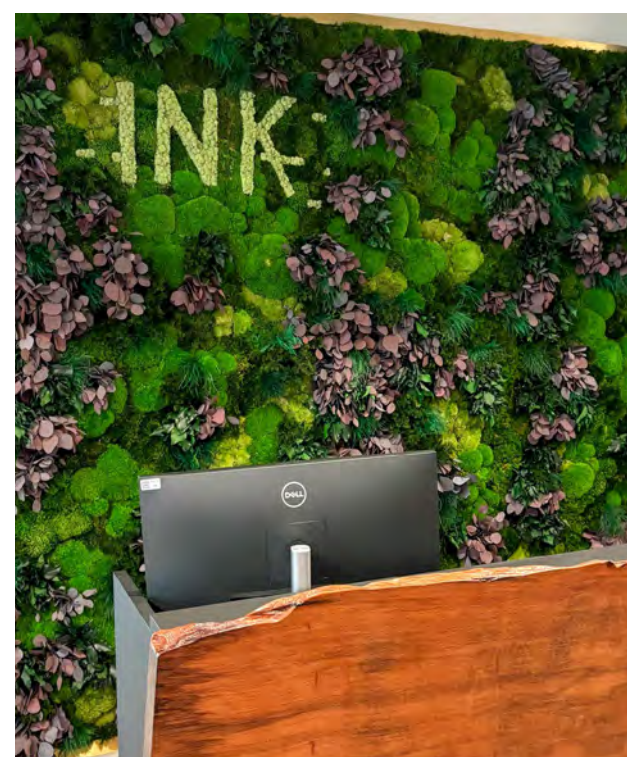
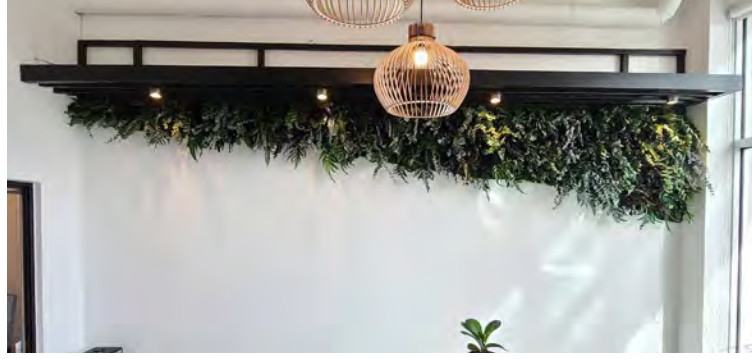
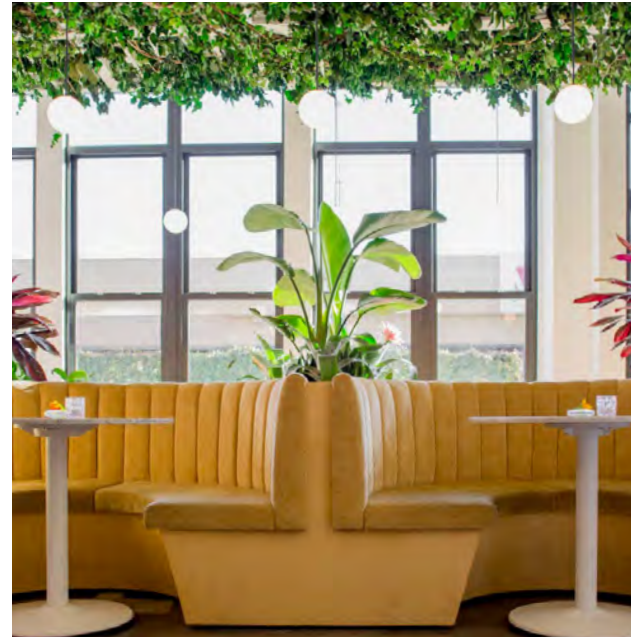

## PRESERVED TREES

ByNature's exclusive line of trees are 100% naturally preserved. Using an innovative process, moisture in the plant is replaced with a vegetable-based glycerin solution, a component that does not evaporate over time. This process preserves the tree's natural feel and beauty for years with limited maintenance required (no natural light, trimming or water required).

- Low maintenance, water or light required
- Long lasting preserved natural trees
- More than 50 different species
- Sizes ranging from 1 ft to 20 ft
- 100% natural

Large diversity of sizes, shapes, textures and colours available





# FAUX

A great imitation of nature, the authentic colours and textures mimic living plants perfectly and like real plants, have a positive impact on the way people feel in a space. When living or preserved plants do not work in a space because of indoor environmental conditions, these exquisite faux plants become the best option.

## FAUX PLANTS

A great imitation of nature, the authentic colours and textures mimic living plants perfectly and like real plants, have a positive impact on the way people feel in a space. When living or preserved plants do not work in a space because of indoor environmental conditions, these exquisite faux plants become the best option.

More than 100 options available



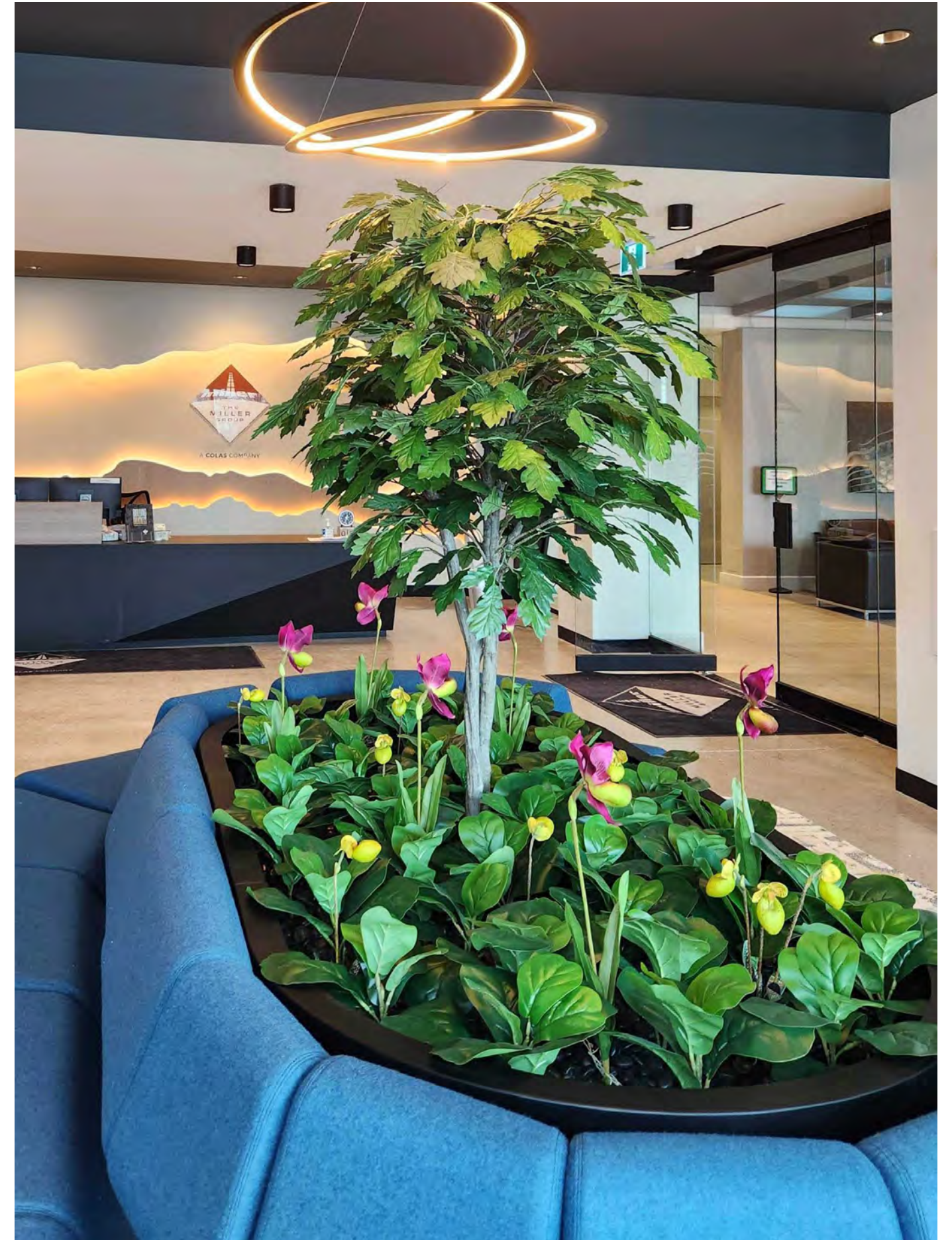
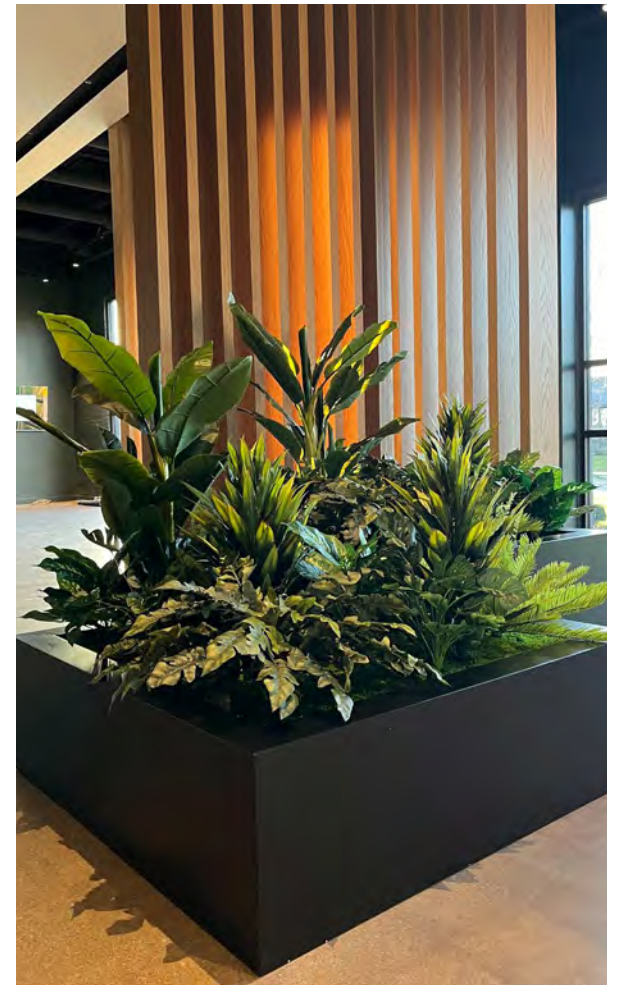

## FAUX PANELS

Our faux panels are used to create stunning vertical gardens. This product will bring the organic shapes and colours of nature to your space with zero maintenance.

Each faux panel has been carefully designed to mimic the growing patterns and movement of natural foliage and to prevent any visible repetition in planting.

- The panels can be cut to fit bespoke areas
- Fire and UV solar weather tested foliage
- Light weight aerated system



## FAUX FLORA

35.55" x 35.55" (20lb)

### ALL GREEN

TND - 30



### DESIGNER LAVENDER

TND - 34



### LUXURY WHITE

TND - 05



### DESIGNER WALL

TND - 38



### LUSH GREEN PLUS YELLOW

TND - 04



Rigid background

GREENLINE

39.5" x 39.5" (6lb)

LUSH JUNGLE  
TNB-60-5



ALL GREEN TROPICAL  
TND - 23



SMALL RIVER FLOWS  
TNB-95



WHITE FLOWER GARDEN  
TNB - 62

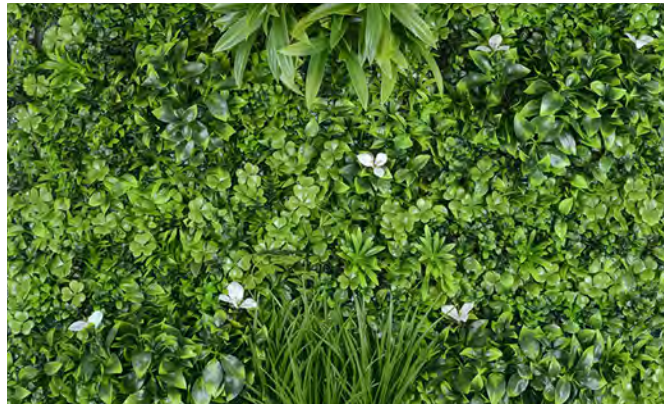

Flexible background

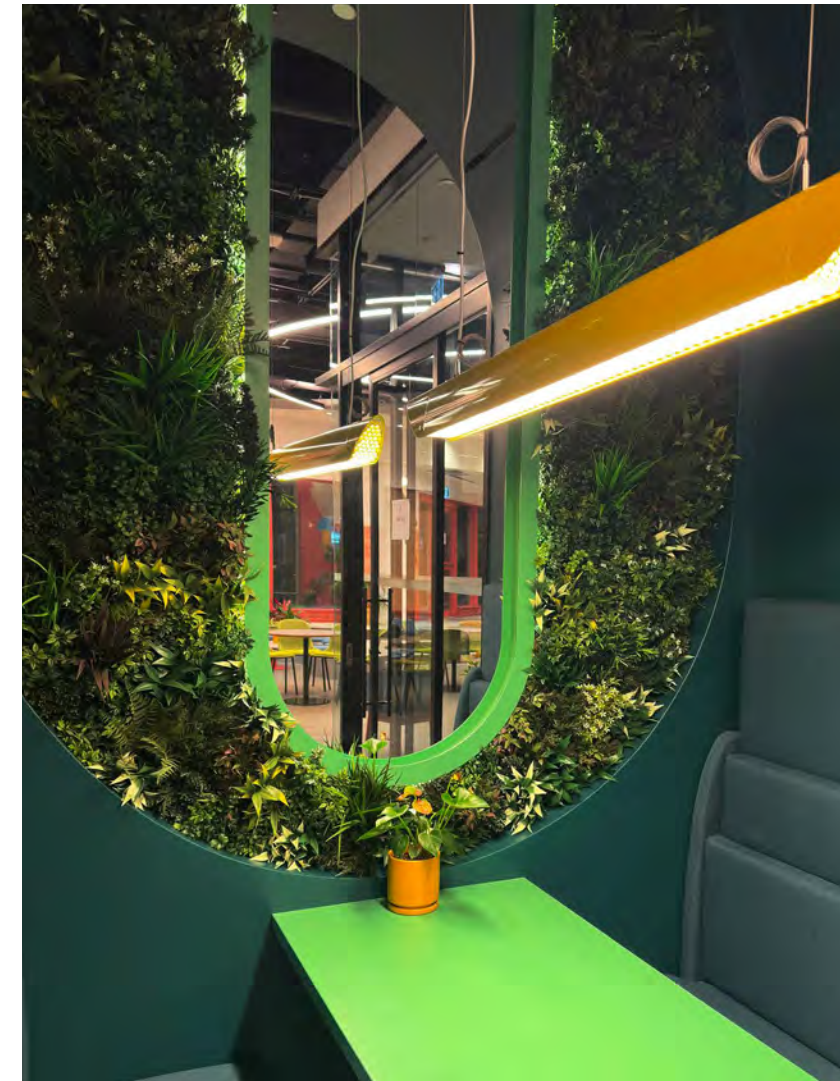

## FAUX CEILINGS

ByNature's faux ceiling installations are a beautiful way to add cascading greenery from above, without the natural limitations of our live or preserved products. The wide selection of faux plants ensures you will have a truly unique installation in your space.



For more details, ask for full brochure

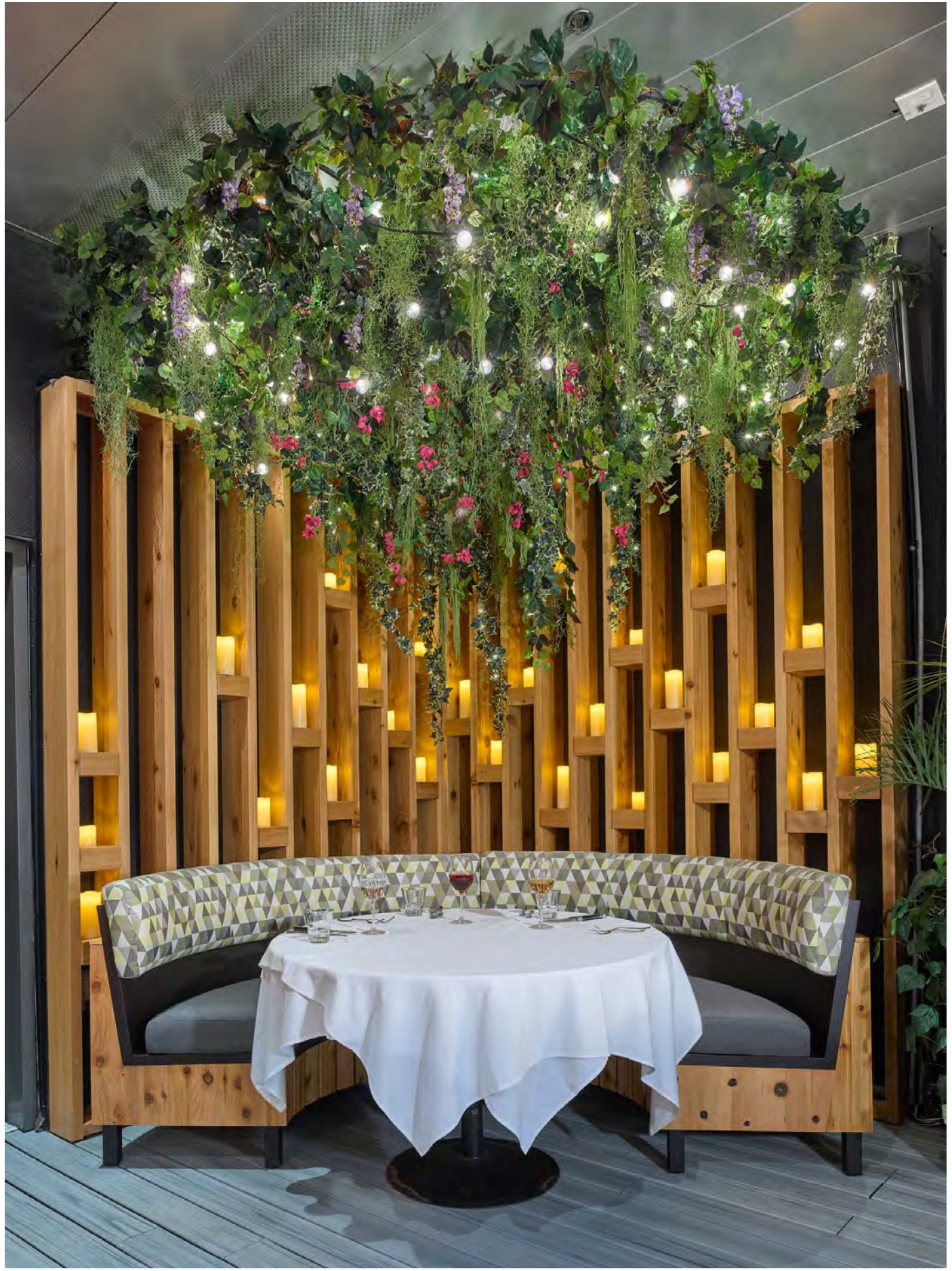

# LIVING

Living plants clean indoor air by absorbing toxins, increasing humidity and producing oxygen. Adding live plants to an office space can be used to create privacy, reduce noise and improve overall air quality.

## LIVE PICTURES & LIVE DIVIDERS

All Live Systems use a cloth wick to deliver water to the plants, so there is no need for pumps, drip lines, electricity or plumbing.

- Low maintenance; water once every 3-4 weeks
- Easy installation - no plumbing or electricity required
- Lightweight system can be installed directly onto drywall
- Easy cassette replacements and seasonal rotations
- Interchangeable plant cassettes
- Wicking irrigation system
- Customizable frames

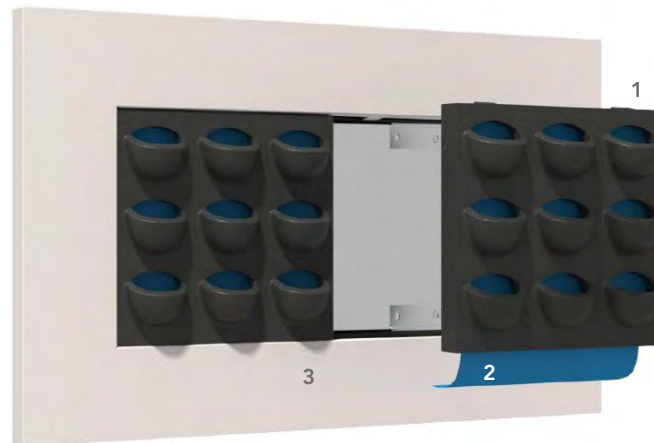

1. Cassette (9 four inch plants each)  
15.75 x 15.75 x 3.5 inch
2. Cotton wick
3. Gutter/reservoir

For more details, ask for full brochure



**LIVEPICTURE 1**  
28.5 x 28.5 x 2.75 inch - 26.5 lb  
Holds 9 plants



**LIVEPICTURE 2**  
44.5 x 28.5 x 2.75 inch - 36.5 lb  
Holds 18 plant



**LIVEPICTURE 3**  
60 x 28.5 x 2.75 inch - 46.5 lb  
Holds 27 plants



**LIVEPICTURE 4**  
76 x 28.5 x 2.75 inch - 56.0 lb  
Holds 36 plants



**FREESTANDING LIVE DIVIDER**  
71 x 44.5 x 5.5 inch



- 54 four inch plants per side
- 205 lb (single sided)
- 282 lb (double sided)
- 20 gallons water capacity

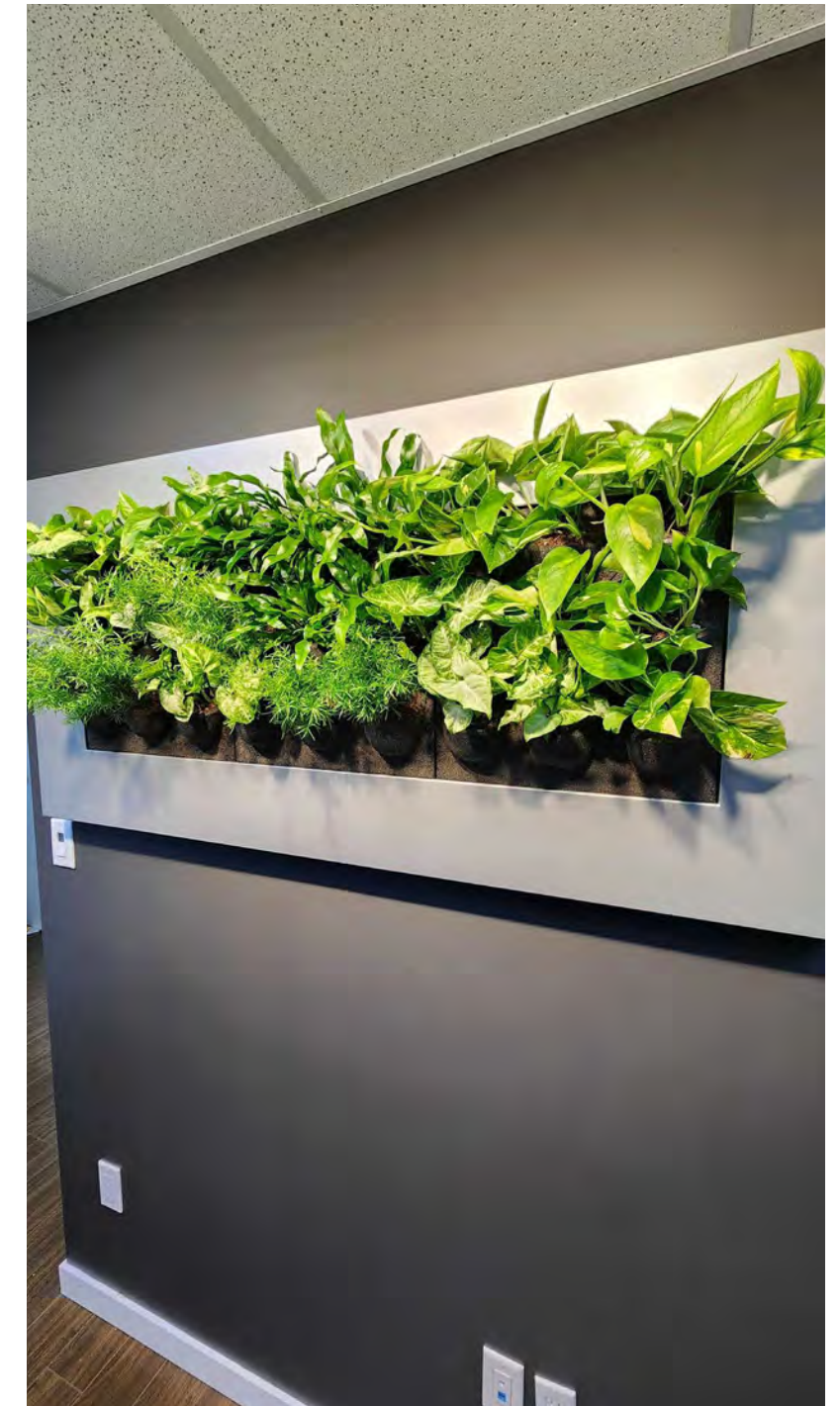

## NEXTGEN LIVING WALLS

Easy to install and to plant, "plug and play" system, virtually any kind of plant can thrive in the NextGen Living Walls.



For more details, ask for full brochure



- Works with plants in their original grow pots
- Plug and play system
- Easy plant rotations
- Easy maintenance
- 3-4 weeks watering cycle



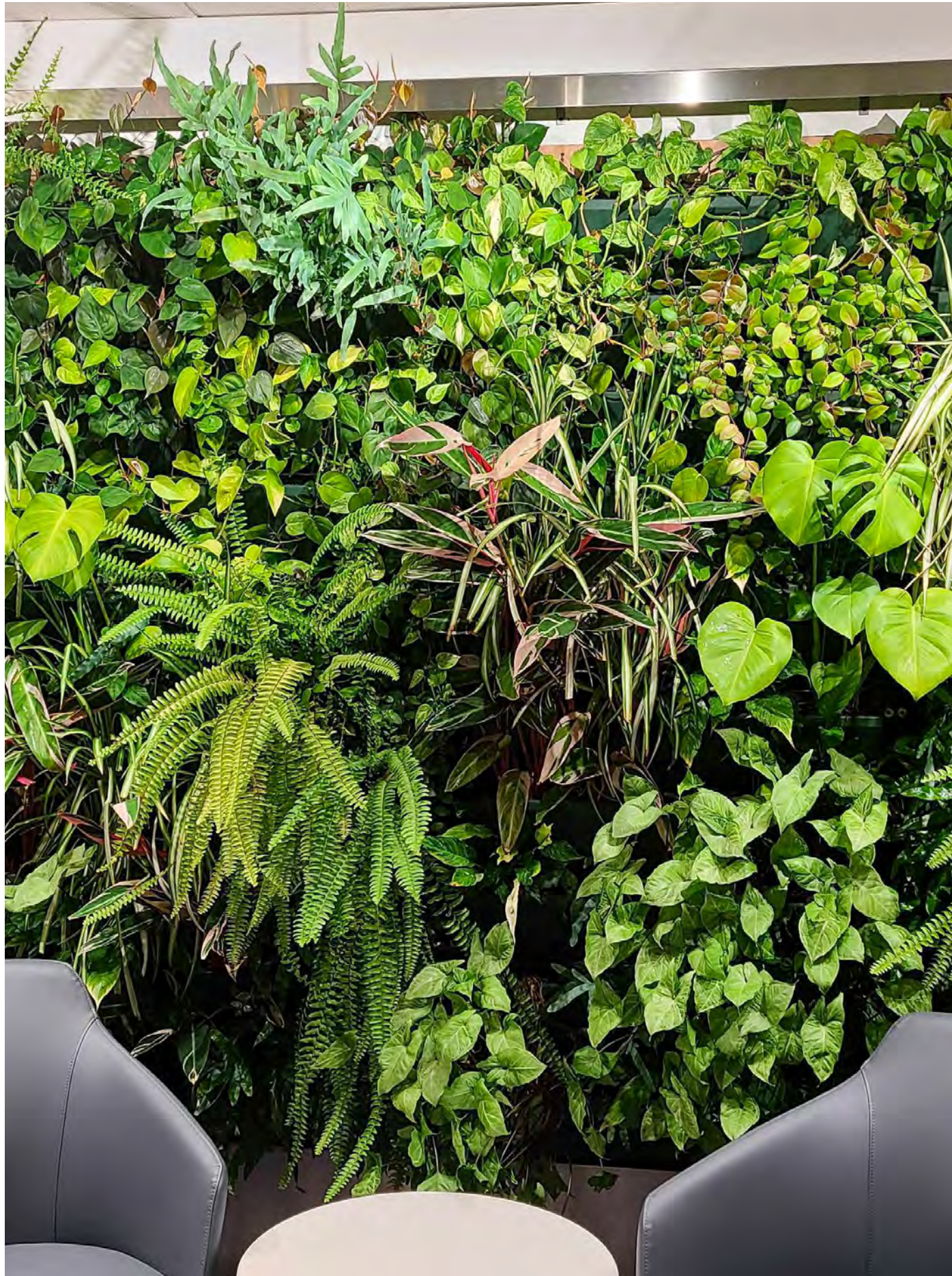

## MOBILE WALLS

In consideration of evolving needs for organized, functional, individual work areas, within open space, these flexible mobile walls are the perfect solution.

- Great partition walls
- Easy to move around the space
- Available in one-sided and two-sided models
- Sturdy cover to hide frame
- Available with Preserved, Living and Faux options

Structures available with Mossart Folia and Living options



(41" wide)



# PLANTERS

ByNature is proud to announce that we can now accommodate your planter requests. We can customize (colors, shape and sizes) planters out of aluminum, stainless steel as well as fiber glass.

ByNature also supplies liners and self watering systems that can be integrated to any planters.

## SELF-WATERING PLANTERS

Our Self-Watering Planters allow you to have live plants without the maintenance of traditional planters. Various designs and sizes available for tabletop and floor.

- Fill the water reservoir once every 4 to 6 weeks (water from the top for the first 8 weeks)
- Floor and tabletop designs available
- Wicking irrigation system
- Over 200 colour & style options
- Custom designs available
- 6 available finishes:
  - stainless steel
  - plastic
  - aluminum
  - fiberglass
  - concrete
  - clay



### SYSTEM

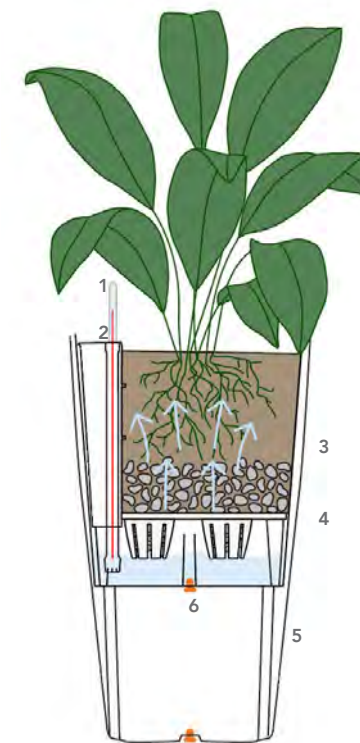

1. Water level indicator
2. Water supply shaft
3. Lechuza® absorbing aggregates
4. Seperator
5. Water reservoir
6. Drain plugs



We distribute several planter lines in various finishes. Ask us for more details

## CUSTOM PLANTERS

Depending on your space and needs, ByNature offers different options when it comes to planters: living planters, faux planters and preserved planters. Our planters promote a healthier indoor environment by improving air quality and reducing stress.

### 1. FIND YOUR PLANTER

If you don't already have a planter for your project, we offer a variety of planter lines:

- different sizes
- different shapes
- different finishes:
  - fiberglass
  - aluminium
  - metal
  - granite
  - fiber clay
  - fiber stone
  - wood



### 2. SELECT YOUR PLANTS



- **Faux plants**  
From the texture of the leaves to the vibrant hues of the petals, every detail is designed to achieve a lifelike appearance.
- **Living plants**  
We source only the healthiest and most robust specimens from trusted nurseries, ensuring that they thrive in their new environment.
- **Preserved plants**  
We offer a very wide variety of preserved products, with 500 options stored in our Canadian warehouses.

### 3. CHOOSE YOUR GROUND COVER

As a final touch for your planters, you need to find the perfect ground cover. We offer a few different options you can choose from – every option has its perks, especially for living plants, so we really advice you to talk to your sales representative about it.

#### BARE GROUND COVER

Bare ground cover means the soil will stay visible.



#### MOSS GROUND COVER

We have the option to have a moss ground cover.

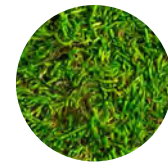

#### RIVER ROCK GROUND COVER

Rocks can be chosen as ground cover as they prevent the evaporation of water and add a natural pop of color. This is a selection of our most popular colors; they can be mixed together.



earth blend



dazzling white



charcoal crushed



polished black



polished yellow



polished red



polished white



dovey grey

#### PLANTS GROUND COVER

Plants can be used as ground cover to give more of a natural and organic look. It will help purify the air and give more depth to your planter. This is a selection of our most popular plants; they can be mixed together.



Philodendron cordatum



Pothos golden



Pothos marble queen



Pothos neon



Pothos pearl & jade

For more varieties of plants, ask for full brochure

#### OTHER

We have more options for ground cover.



mulch

Contact us for more options

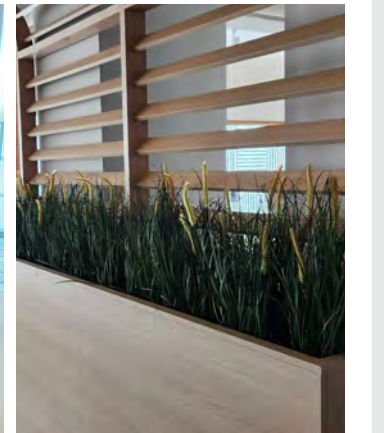
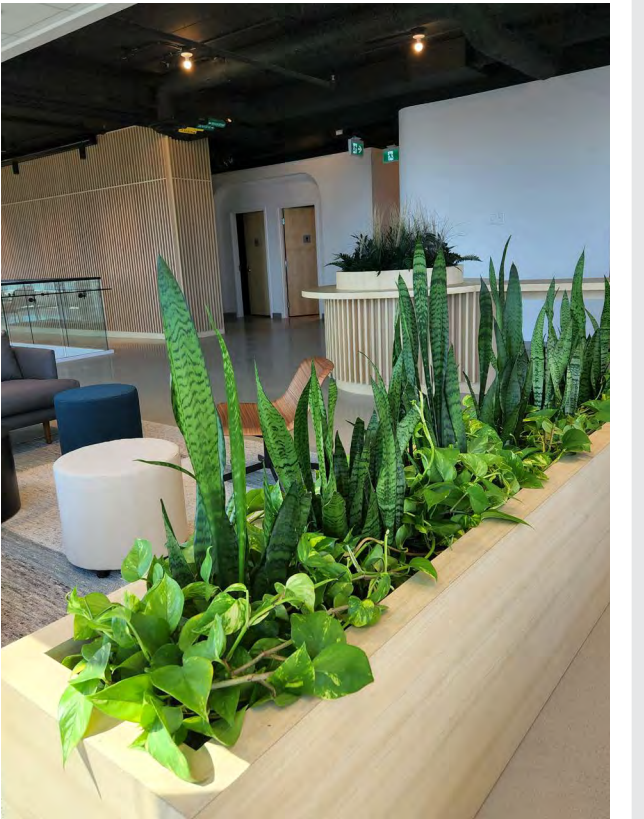
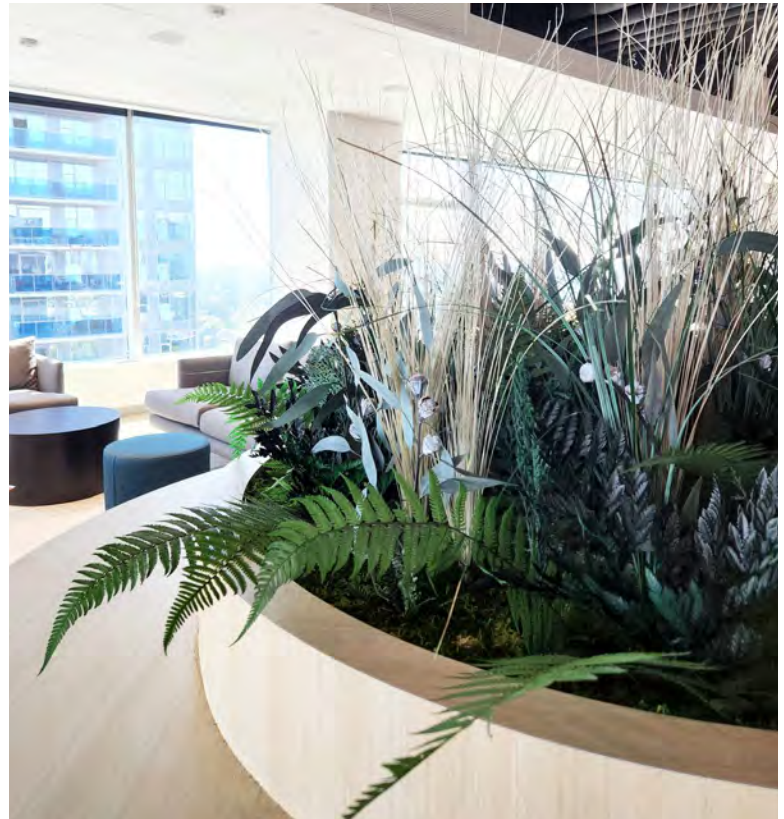
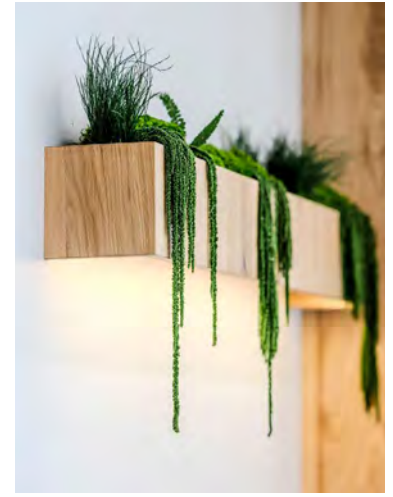



## SUSPENDED GREENERY

We believe that greenery should be part of our every day decor. ByNature offers hanging pieces, and light fixtures featuring lush greenery for a natural aesthetic. They can integrate our living, faux and preserved products in their design. It is now very easy to add plants in your indoor space!

## WELL PLANTER

The Well Planter is elegant and minimalist by design. The modern, white basin diffuses light beautifully, and accentuates lush hanging plants.

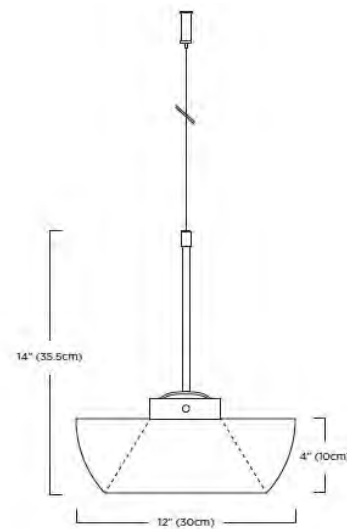

- **Materials:** Aluminum, Brass, Stainless Steel
- **Dimensions:** 30cm x 40cm / 12" x 15.75"
- **Drop Length:** 182cm / 72"
- **Supply:** 120 - 240v
- **Source:** E26/E27 lampholder, Bulb not included
- **Dimmable:** Yes with Triac Type Dimmer
- **Canopy:** Powder-coated Spun Steel
- 15cm x 1cm / 5" x 0.5"
- **Stem Finish:** Unfinished Brass (will patina) or Nickel Plated Brass
- **Basin Finish:** Gloss White Powder Coat



## WELL PLANTER LIGHT

The Well Light is both an evolution of design from the Babylon Light and a refined industrial pendant. The name comes from the use of a 'well glass' diffuser. The removable shade/basin allows for easy maintenance and more growing options such as herbs.

The Well Light provides downlight ideally suited for over a table or work area.

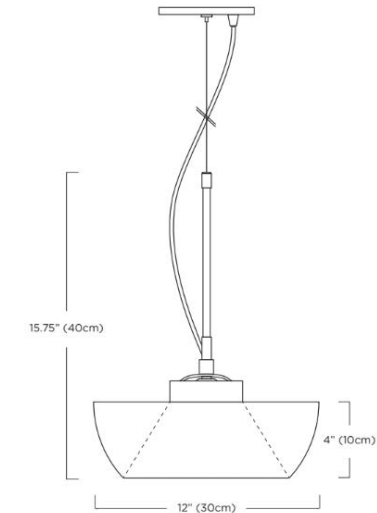

- **Materials:** Powder-coated Spun and Cast Aluminum, Frosted Glass and Stainless Steel hardware
- **Dimensions:** 30cm x 40cm / 12" x 15.75"
- **Drop Length:** 182cm / 72"
- **Supply:** 120 - 240v
- **Source:** E26 lampholder, 60 watt max, Bulb not included
- **Canopy:** Powder-coated Spun Steel, 30cm x 10cm / 12" x 4"
- **Colours:** Dome — Satin White or Matte Black  
Ring — Gloss White or Gloss Black  
Shade — Gloss White or Gloss Black



## HEMISPHERE PLANTER

Add a burst of colour to this unique hanging planter. A minimal hanging planter ideally suited for small succulents or air-plants. Hang a single or multiples in clusters to create a hanging garden landscape in your home.

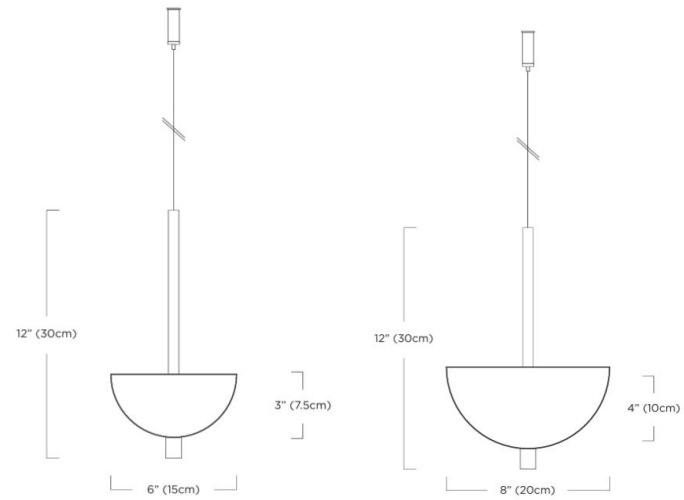

- **Materials:** Aluminum, Brass, Stainless Steel
- **Dimensions:**  
*Small: 6" (15cm) Ø x 12" (30cm)*  
*Large: 8" (20cm) Ø x 12" (30cm)*
- **Cable Length:** 72" (182cm)
- **Finishes:** Aluminum: powder coated gloss white  
 Brass: brushed, uncoated (will patina with use)
- **Origin:** Made in Canada



## HEMISPHERE PENDANT PLANTER

Add a burst of colour to the soft curves and refined brass details of the Hemisphere Pendant while the opal glass diffuser will softly light your space.

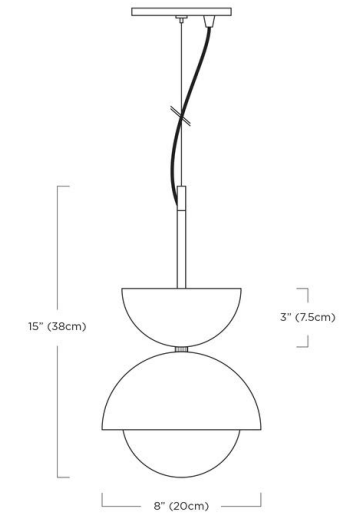

- **Materials:** Aluminum, Brass, Stainless Steel, Opal Glass
- **Dimensions:** 8" (20cm) x 15" (38cm)
- **Drop Length:** 72" (182cm)
- **Supply:** 120 – 240v
- **Source:** G9 lampholder, Bulb not included
- **Canopy:** Powder-coated Steel 5" (15cm) x 0.5" (1cm)
- **Finishes:** Aluminum: powder coated gloss white  
 Brass: brushed, uncoated (will patina with use)



## BABYLON LIGHT

Inspired by the hanging gardens of Babylon, the Babylon Light is a multifunctional pendant for those who love plants but not the clutter of flowerpots.

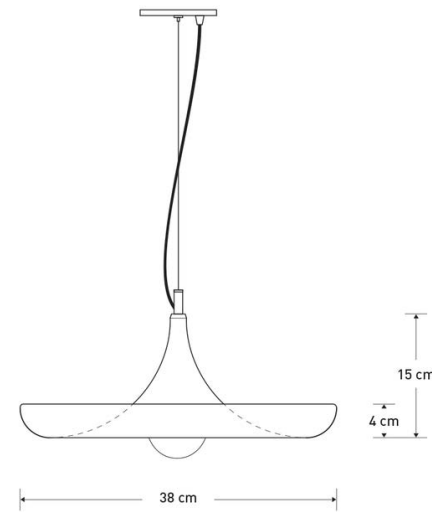

- **Materials:** Powder-coated Spun Aluminum, Stainless Steel Cable, Nickel-plated Hardware
- **Dimensions:** 38cm x 15cm / 15" x 6"
- **Drop Height:** 182cm / 72"
- **Supply:** 120 – 240v
- **Source:** E26 lampholder, 60 watt max, Bulb not included
- **Canopy:** Powder-coated Spun Steel, 15cm x 1cm / 5" x 0.5"
- **Colour:** Gloss White

All light fixtures can be planted with living, preserved or faux plants



## NATURAL WALL COVERING

By Nature brings greenery indoors but not just greenery - we try to always offer sustainable solutions to surround plants and moss with quality products.

## NATURACORK

Great addition to any preserved product or on its own, our Naturacork line will bring natural textures to your space. It is a natural acoustic product, sustainable, hypo-allergenic and fire-retardant.

### CORK BRICKS



- Dimensions: 25/32" x 9 29/64" x 31 1/2" (20mm x 240mm x 800mm)
- One Tile = 2.07 sqft
- Coverage per carton: 22.77 sqft
- Tiles per carton: 11
- Finish: Water Based Polyurethane
- Material: 100% Cork
- Applications: wall
- Made in Italy



### CORK PANELS



- Dimensions: 55/64" x 12" x 24" (22mm x 304mm x 610mm)
- One Tile = 2 sqft
- Coverage per carton: 18.02 sqft
- Tiles per carton: 9
- Finish: Water Based Polyurethane
- Material: 100% Cork
- Applications: wall
- Made in Italy



## GENCORK

Gencork is a perfect sustainable choice for your indoor space as it combines elegance with ecological low-tech material. These cork panels are based on generative design.

- 100% natural and recyclable
- 95% energy self-sufficiency production
- Hypoallergenic properties
- Water and weather resistant
- Great sound absorber
- Preservation and respect for trees
- Misuse can cause product deterioration
- Digital fabrication
- Color changes with exposure to sunlight
- Scent is natural, non-toxic and disappears with time
- Made in Portugal

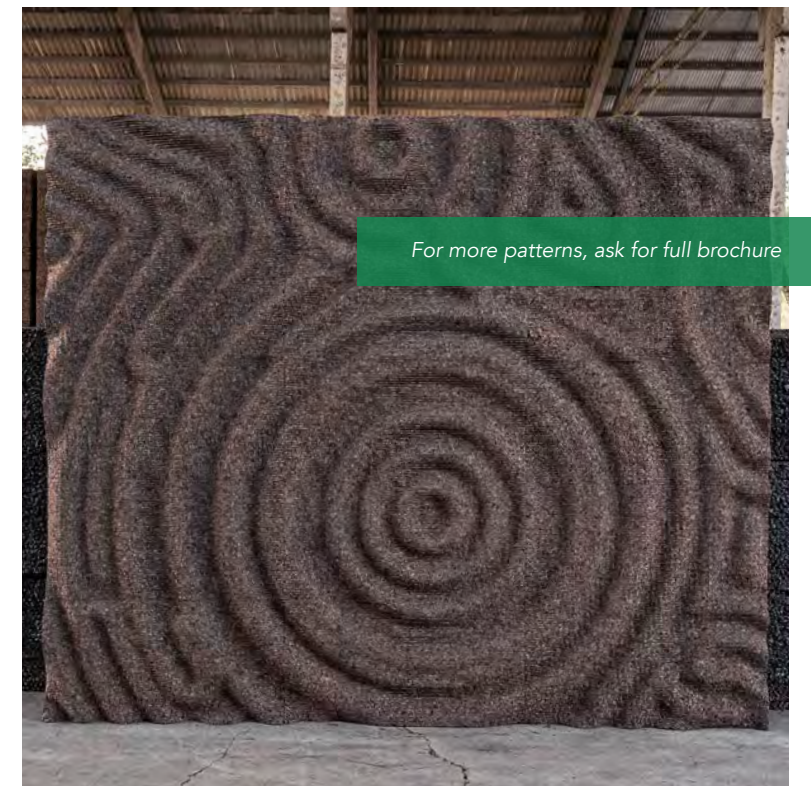
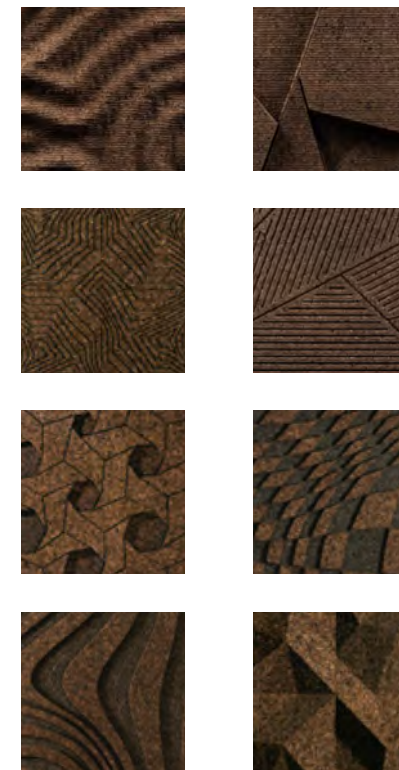

For more patterns, ask for full brochure

# PAPIERFLORA

PapierFlora evokes memories and bring nature indoors. When you touch it, you experience fascinating textures with a natural character. And the scents? Fresh hay, roses, or herbs – they not only improve the air but also lift your mood.



## WALLPAPER

A fell-good atmosphere to touch, smell, and experience.



## ADHESIVE FOIL

Adheres to walls, furniture, and glass; ideal for privacy protection.



## DÉCOR

Custom interior design and furniture with character.

## SPECIFICATIONS

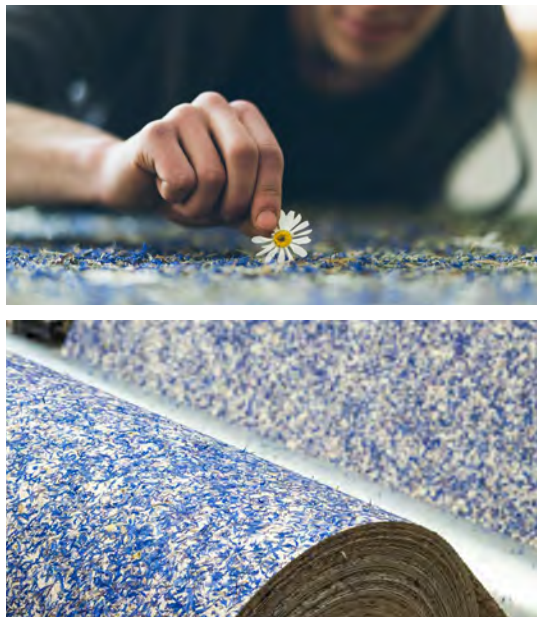

- more than 35 designs available
- handmade in Tyrol, Austria
- 100% carbon-neutral
- rapidly renewable and up-cycled materials
- versatile applications
- custom solutions
- allergy-free
- certifications: allergy testing, fire protection, emissions testing, food safety etc.



## AVAILABLE DESIGNS



Alpine Meadow



Mountain Meadow



Carpe Diem



Hops Gold



Coffee Leather



Cornflower Blue



Lavender Medium



Moss Grey



Moss Mix



Relax



Alpine Meadow Light



Rose Petals



Skeleton Leaves



Skeleton Leaves Gold



Wildspitze Blue



Wildspitze Light



Wildspitze Rose Garden



Wildspitze



Wildspitze Gold



Wool



Stone Pine Forest

For more patterns, ask for full brochure



**ByNature Import Inc**  
1.855.436.2919  
info@bynaturedesign.com  
www.bynaturedesign.com



*Vancouver - Calgary - Toronto - Montreal - Quebec (City) - New York  
Canada - USA - Europe*